

FEATURES:

- ✓ Architectural sound absorbing Eco Felt Acoustic panel.
- ✓ Made from recyclable plastic material available in different thicknesses.
- ✓ Class1 Fire rated with 0.7 Noise Reduction Coefficient/1" Acoustic.
- ✓ Light source: LED Board (5.5"/11"/22"/24").
- ✓ Diffused illumination is provided by frosted opal lens.
- ✓ Extruded aluminum body comes with built-in-driver and available in white, black or grey finish.
- ✓ Also available with custom colour options.
- ✓ LED Strips are rated for 60,000hrs. L80 with +90 CRI.
- ✓ Has a proven record in office, commercial and retail installations.
- ✓ Custom modifications are available.
- ✓ ED luminaires are certified to CSA and UL Standards. **reinventlight**

SPECIFICATION:

Sonic VECTOR+ - - - - - - - - - - - -

Enter the Product Code into the boxes above.

- | | | | | | |
|-------------------------------------|--|-------------------------------|----------------------------|--|---|
| TYPE | HEIGHT | SIZE | SOURCE | RADIANCE | VOLTAGE |
| <input type="checkbox"/> CS - Cloud | <input type="checkbox"/> 16 Inch
<input type="checkbox"/> 18 Inch
<input type="checkbox"/> 24 Inch | 32 Inch
42 Inch
52 Inch | 20WLED
30WLED
40WLED | <input type="checkbox"/> DD - Direct (100%Down)
<small>*Light Distribution.</small> | <input type="checkbox"/> 120V
<input type="checkbox"/> 277V
<input type="checkbox"/> 347V*
<small>*Not available for all configurations.</small> |

- | | | | | |
|--|--|------------------------------------|--|--|
| DRIVER | MOUNTING | LENS | ED VECTOR+ FINISH | CCT |
| <input type="checkbox"/> ST - Standard (Non-Dimming)
<input type="checkbox"/> DL - 0-10V Dimming (1%)
<input type="checkbox"/> DA - DALI
<input type="checkbox"/> BT - Bluetooth*
<input type="checkbox"/> <input type="text"/> ** | <input type="checkbox"/> S4-Suspension 4Feet
<input type="checkbox"/> S6-Suspension 6Feet
<input type="checkbox"/> S <input type="text"/> Feet*
<small>*Please specify required Length.</small> | <input type="checkbox"/> OP - Opal | <input type="checkbox"/> WH - White
<input type="checkbox"/> BK - Black
<input type="checkbox"/> GR - Grey*
<input type="checkbox"/> CF - Custom <input type="text"/> RAL#
<small>*Supply with White Cord & Canopy
** Please provide 600dpi Image.</small> | <input type="checkbox"/> 30K/90CRI - 3000Kelvin
<input type="checkbox"/> 35K/90CRI - 3500Kelvin
<input type="checkbox"/> 40K/90CRI - 4000Kelvin
<input type="checkbox"/> RGBW
<input type="checkbox"/> TW - Tunable White**
(2700K-6500K)
<small>*Available with Dali, DMX or Bluetooth controls.
**Available with 0-10V/Dali or Bluetooth controls.</small> |

ACOUSTIC FINISH

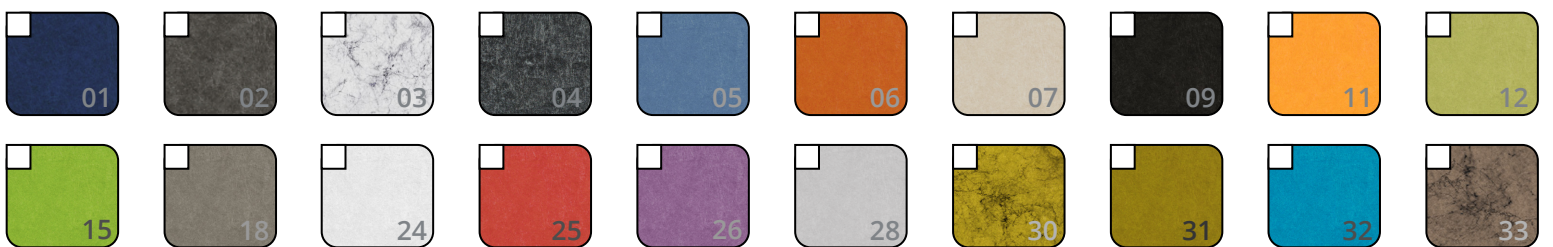

LUMEN OUTPUT W/Ft:

Watts	30K	35K	40K
20W	2080 lm	2120 lm	2160 lm
30W	3115 lm	3180 lm	3245 lm
40W	4115 lm	4240 lm	4325 lm



Project:

Type:

SIZE:

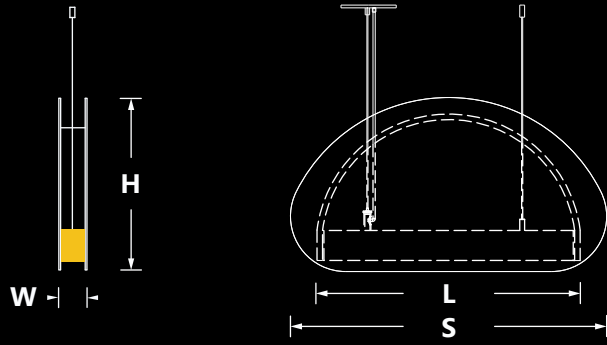

RADIANCE:

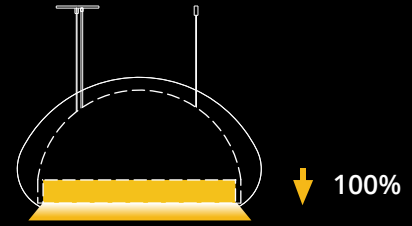

DIRECT DISTRIBUTION

H - Height	S-Size	L - Luminare Length	W - Width
16 Inch = 15.75 Inch	32 Inch	22.80 Inch	2.75 Inch
18 Inch = 17.75 Inch	42 Inch	33.80 Inch	
24 Inch = 23.75 Inch	52 Inch	44.80 Inch	

FINISHES:

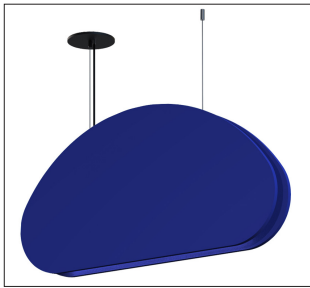

#01

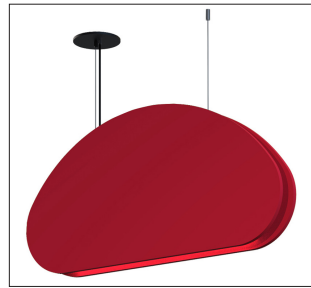

#25



#11

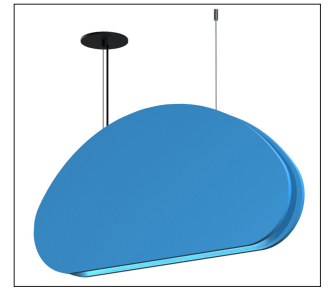

#32



#26



#18



#06

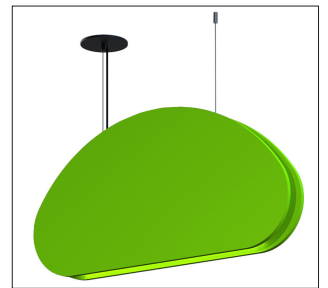

#15